

**MC SQUARE EDUCATION PVT.LTD**

TEST DATE-24/03/2018

TARGET: **NEET 2018 EXAM**

RESULT -FINAL ASSAULT: **MOCK TEST 01**

TOTAL MARKS-720

**CUTOFF MARK: 450**

SR	STUDENT NAME	CHEMISTRY		PHYSICS		BIOLOGY		MARKS
		CORRECT	INCORRECT	CORRECT	INCORRECT	CORRECT	INCORRECT	
1	PREETISH DEVADHE	14	14	9	12	54	28	254
2	MAHESHWARI NALE							ABSENT
3	VIGHNESH PATIL	23	7	14	6	31	20	359
4	AKSHATA CHEREKAR	13	10	6	4	27	23	147
5	RISHIKA TRIPATHI	35	9	23	11	70	14	478
6	PRATIKSHA DHOTARE	19	17	6	4	51	29	254
7	POOJA SINGH	17	4	10	5	50	27	272
8	MONIKA CHOUDHARY	35	6	19	7	68	15	460
9	PRIYANKA KADAM	30	10	20	10	60	14	406
10	ARUNDHATI GOTEKAR							ABSENT
11	SHAMLI KAMBLE	8	16	5	6	20	34	76
12	MANISH DESALE	18	11	14	5	39	26	242
13	PAYAL MUNDE	12	8	3	7	51	17	232
14	VAISHALI SHELKE							ABSENT
15	VIVEK ARBAN	23	15	10	8	60	24	325
16	DIVYA PANCHAL	7	10	6	13	51	34	263
17	BHAVESH JAISWAL	15	7	14	4	42	19	254
18	RUTUJA VIBHUTE	22	15	18	3	60	23	359
19	ADITI BORSE	19	19	5	13	54	28	252
20	AKSHADA GAGALE	15	10	17	6	36	27	229
21	CHANDRAMANI WAGH							ABSENT
22	DIVYANI PETARE							ABSENT
23	KIRTI DHAVANE							ABSENT
24	NILESH BHEGADE	15	6	1	0	48	19	231
25	JAHNAVI GUGALE	13	13	7	3	46	22	226
26	ABDULLA KHAN	13	19	8	13	27	35	125
27	AISHWARYA SURYAWANSHI	26	8	18	5	66	14	413
28	MRUNAL CHOUGULE	24	9	15	4	64	17	382
29	SNEHA BORATE							ABSENT
30	KARTIK JAIN	17	11	6	6	43	13	234
31	VYASGHAWATE	14	7	16	12	38	18	235
32	HARSHADA MALEKAR	21	7	10	2	46	25	274
33	MOHINI SONAWANE	14	7	5	4	37	29	184
34	DARSHANA HIPARGI	28	13	11	5	68	16	394
35	AMIRTHESH PILLAI	14	4	17	6	55	29	305
36	REKHA CHOUDHARY	24	8	1	0	36	31	205
37	SANKET GAIKWAD	10	7	3	1	48	17	219
38	SAMIKSHA PANMAND	10	23	4	8	24	35	86
39	HITESH DHARMADHAKARI							ABSENT
40	VEDIKA BHOSALE	9	9	2	2	30	15	138
41	AKANKSHA GURV	6	2	2	1	42	18	179
42	MANSI DESHMUKH	12	19	5	2	37	29	166
43	DEEPALI PATIL	18	26	5	16	38	51	151
44	MAYURI MORE	3	6	2	4	14	11	55
45	ANIRUDHHA SALUNKHE	6	7	3	7	30	22	120
46	ISHA HULSURKAR	10	9	5	12	12	24	63
47	SONAM GHORPADE	11	3	4	1	37	16	188
48	APURVA WAGHMARE	8	19	2	3	8	35	15
49	SHARAYU SHINDE							ABSENT
50	KAVYA PATHAK	12	9	2	3	15	30	74
51	SANIKA MAHAJAN							ABSENT
52	KAUSTUBH AHIRRAO	10	17	2	7	40	37	147

**MC SQUARE EDUCATION PVT.LTD****TEST DATE-24/03/2018****TARGET: NEET 2018 EXAM****RESULT -FINAL ASSAULT: MOCK TEST 01****TOTAL MARKS-720****CUTOFF MARK: 450**

53	OMKAR BAKWAD	5	12	2	6	31	36	98
54	ADITI SHINDE	13	10	3	3	16	16	99
55	ANUJA KHOSE	10	8	4	5	24	24	115
56	AKASH NIKAM	15	7	14	4	42	19	254
57	SHRAVANI CHAVAT	22	17	13	22	55	28	303
58	SAHIL GAIKAR	13	24	10	33	21	64	55
59	SWAPNALI HANGE	15	7	3	2	27	15	156
60	MAHEFUZ PATHAN	10	11	3	7	14	24	66
61	ADITYA SASANE	19	12	4	5	60	20	295
62	RUTUJA SASANE	16	9	4	4	53	21	258
63	POTDAR PRADNYA PRADEEP	1	8	1	0	10	20	20
64	SIMRAN	31	9	19	6	70	11	454
65	RASHMI PURI	5	10	5	9	49	37	180
66	RASANE PURVA	16	11	8	3	48	38	236
67	SAKSHI CHOUDHARY	6	12	4	4	42	22	170
68	ROHINI PAWAR	14	21	7	11	40	48	164
69	SAMARAGI HATI	20	11	14	11	57	25	317
70	AISHWARYA BORHADE	17	9	4	3	57	13	287

# NEET

## TEST-1-SOLUTIONS

---

STANDARD ANSWER KEY											
Q	1	2	3	4	5	6	7	8	9	10	11
A	C	B	D	A	C	C	B	D	D	B	C
Q	12	13	14	15	16	17	18	19	20	21	22
A	B	C	C	B	A	B	A	A	A	C	C
Q	23	24	25	26	27	28	29	30	31	32	33
A	B	D	A	A	C	C	A	C	B	A	C
Q	34	35	36	37	38	39	40	41	42	43	44
A	A	A	C	C	B	A	B	D	B	B	A
Q	45	46	47	48	49	50	51	52	53	54	55
A	B	B	D	A	D	A	A	A	C	B	C
Q	56	57	58	59	60	61	62	63	64	65	66
A	D	A	D	D	B	B	C	C	B	D	A
Q	67	68	69	70	71	72	73	74	75	76	77
A	B	A	A	B	B	B	B	C	C	C	B
Q	78	79	80	81	82	83	84	85	86	87	88
A	C	A	C	C	B	D	B	A	C	C	C
Q	89	90	91	92	93	94	95	96	97	98	99
A	D	A	C	A	D	D	C	B	A	D	B
Q	100	101	102	103	104	105	106	107	108	109	110
A	A	C	D	B	D	B	D	B	C	A	A
Q	111	112	113	114	115	116	117	118	119	120	121
A	A	C	D	C	D	C	C	A	B	A	B
Q	122	123	124	125	126	127	128	129	130	131	132
A	B	D	B	B	D	A	A	D	C	B	A
Q	133	134	135	136	137	138	139	140	141	142	143
A	C	A	A	C	D	C	D	D	A	C	C
Q	144	145	146	147	148	149	150	151	152	153	154
A	D	C	D	C	D	C	D	A	B	C	A
Q	155	156	157	158	159	160	161	162	163	164	165
A	C	A	D	A	C	D	D	B	D	C	C
Q	166	167	168	169	170	171	172	173	174	175	176
A	A	C	C	D	C	C	C	B	C	C	B
Q	177	178	179	180							
A	C	B	C	C							

- (1) (C). The statement is incorrect since the nucleus of an atom, consisting of protons and neutrons, represents the majority of atomic mass. The other statements regarding the Rutherford experiment are true.
- (2) (B). The question asks you to predict bond angles based on VSEPR theory. Notice that all three molecules have tetrahedral geometry (all have four groups surrounding the central atom), and thus all bond angles will be approximately  $109.5^\circ$ . Remember that repulsive forces are highest between electron lone pairs and lowest between bonding pairs. In  $H_2O$ , there are two lone pairs that will be positioned as far as part as possible in order to minimize repulsion, thus pushing the other groups together. So the HOH bond angle in  $H_2O$  will be smallest (about  $104.5^\circ$ ). By using the same logic, the one lone pair in  $NH_3$  will push the bonding pairs closer together, so the HNH angle will be about  $107^\circ$ . For  $CH_4$ , there are no lone pairs and thus all bond angles will be equal ( $109.5^\circ$ ).
- (3) (D). Although  $CH_2Cl_2$ ,  $CH_3CH_2OH$ , and  $HF$  all have a net dipole moment, the dipole moment of  $HF$  is largest due to the large electro negativity difference between H and F.
- (4) (A). The only molecule containing a triple bond is  $C_2H_2$ , or ethyne.
- (5) (C). Remember that boron often does not obey the octet rule. In this case, the boron atom is surrounded by three groups making the geometry of  $BF_3$  trigonal planar and the boron atom  $sp^2$ -hybridized.
- (6) (C). We expect that the ideal gas laws are least likely to apply when molecular volume matters and attractive forces between molecules is greatest. This is most likely to occur at high pressure (where the volume of particles matters) and at low temperatures (since the attractive forces between gas particles is significant). At low pressures (and high volumes), the concentration of gas molecules is less and attractive forces are not as significant.
- (7) (B). To solve the equation, we need to look at the ideal gas equation to establish a relationship between temperature and pressure.

Since  $PV = nRT$

$$\frac{P_1}{T_1} = \frac{P_2}{T_2} \quad \text{or} \quad P_2 = \frac{P_1 T_2}{T_1}$$

What is a torr anyway? It's just another unit of pressure, identical to mm Hg. One atmosphere is 760 mm Hg or 760 torr. We should note that sometimes it's not necessary to convert to SI units. However, we would recommend always converting to standard units when in doubt.

$$\text{So } 1,520 \text{ torr} \times \left( \frac{1 \text{ atm}}{760 \text{ torr}} \right) = 2.000 \text{ atm.}$$

Substituting into the equation above (remembering to convert the temperatures to Kelvin):

$$P_2 = \frac{(2.000) \times (423)}{(300)} = 2.84 \text{ atm}$$

- (8) (D). To solve this problem, we must start by determining the number of moles of  $N_2$  in the air bag using the ideal gas equation:  $PV = nRT$

Solving for n :

$$n = \frac{PV}{RT} = \frac{(1.25 \text{ atm})(20L)}{(0.0821 \text{ L atm mol}^{-1}\text{K}^{-1})(300K)}$$

$$n = 1.0 \text{ mol } N_2$$

According to the balanced chemical equation, 2 mol of  $NaN_3$  are needed for every 3 mol of  $N_2$  produced. So:

$$\frac{\text{mol } N_2 \times (2 \text{ mol } NaN_3)}{(3 \text{ mol } N_2)} = 0.67 \text{ mol } NaN_3$$

The corresponding mass of  $NaN_3$  is given by:  
no. of grams of  $NaN_3$

$$= (0.67 \text{ mol } NaN_3) \times \left( \frac{65 \text{ g } NaN_3}{1 \text{ mol } NaN_3} \right) = 44 \text{ g } NaN_3$$

- (9) (D). Since the two gases are both at the same temperature, pressure, and volume, there must be an identical number of moles (and therefore molecules) of gas present in each flask.  $N_2$  has a lower molecular weight than  $CO_2$ , and therefore has a higher average velocity (remember that average molecular velocity is inversely proportional to the square of the molar mass). However, the average kinetic energy of both gases should be the same since average kinetic energy is determined by temperature only, which is identical for both flasks.

- (10) (B). It turns out we don't even need a balanced equation for this, so the formula of sulfur doesn't matter. The formula of aluminum sulfide is  $Al_2S_3$ . We know that aluminum metal,  $Al(s)$ , is limiting, and there are no other aluminum-containing species besides  $Al(s)$  and

$Al_2S_3(s)$ , so the ratio must be  $\frac{1 \text{ mol } Al_2S_3}{2 \text{ mol } Al}$  (in the

balanced equation, it could be 1 : 2 or 2 : 4 or 3 : 6, etc., but that doesn't matter here).

$$23.2 \text{ g } Al \times \left( \frac{1 \text{ mol } Al}{26.98 \text{ g } Al} \right) = 0.860 \text{ mol } Al$$

$$0.860 \text{ mol } Al \times \left( \frac{1 \text{ mol } Al_2S_3}{2 \text{ mol } Al} \right) = 0.430 \text{ mol } Al_2S_3$$

$$0.430 \text{ mol } Al_2S_3 \times \left( \frac{150.14 \text{ g } Al_2S_3}{1 \text{ mol } Al_2S_3} \right) = 64.6 \text{ g } Al_2S_3$$

- (11) (C). This problem can be answered quickly by setting the coefficient for  $K_2CO_3$  to 1 and then solving for the other reactants. Balancing the carbon, potassium and oxygen leaves

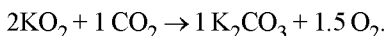

This equation then needs to be doubled to give the balanced equation

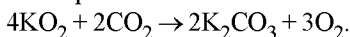

The answer can be checked by simply adding up the number of each element on both sides (e.g., 12 oxygen atoms).

- (12) (B). First, calculate the number of moles of each reactant. There are originally two moles of each reactant ( $142/71 = 2$  and  $88/44 = 2$ ). From the reaction stoichiometry, the reaction consumes twice as much  $\text{KO}_2$  as  $\text{CO}_2$ , so  $\text{KO}_2$  is the limiting reagent. From stoichiometry, for every four moles of  $\text{KO}_2$  used, three moles of oxygen are produced. If the reaction is started with two moles, the reaction will end with

$$\frac{2}{4} \times 3, \text{ or } 1.5 \text{ moles, or } 48 \text{ g of oxygen.}$$

- (13) (C). Only atoms with  $sp^3$  hybridization can give bond angles of  $109.5^\circ$  (tetrahedral), and choices (A) and (C) have central atoms with that hybridization. However, choice (A) has lone pairs on the central atom, where choice (C) does not. According to VSEPR theory, lone pairs will cause more repulsion than bonds and push the bonds closer together (less than  $109.5^\circ$ ). Choice (C), therefore, is the best answer.

- (14) (C). The combined gas law is needed for this question:

$$\frac{P_1 V_1}{T_1} = \frac{P_2 V_2}{T_2}$$

Plugging in the values given in the

$$\text{question produces } \frac{3P_1}{300} = \frac{2P_2}{200}, \text{ so } P_1 = P_2.$$

- (15) (B). First, realize that there is a limiting reagent for the reaction:  $\text{H}_2$ . The equation shows that for each mole of hydrogen consumed, two moles of  $\text{HCl}$  are produced. Since the volume of gases is directly proportional to their number of moles, the volume of  $\text{HCl}$  produced would be  $2 \times 2 = 4 \text{ L}$ .
- (16) (A). As the energy of the orbitals increases, so does the average distance from the nucleus, so the orbital filled first (s) is also the one closest to the nucleus.

(17) (B). 
$$P = \frac{nRT}{V}$$

Remember that chlorine gas is  $\text{Cl}_2$ , not  $\text{Cl}$ , so 35 grams of  $\text{Cl}_2$  is only 1/2 mole, or 0.5 mole. The third common pitfall is failing to convert temperature into the Kelvin scale; you must always use temperatures in Kelvin; but they are usually given in  $^\circ\text{C}$ .

- (18) (A). The enzyme must contain at least one atom of Se.

$\therefore$  0.5 g of Se is present in 100 g of enzyme

$$\therefore 78.4 \text{ g of Se will be present in } \frac{100 \times 78.4}{0.5} = 1.576 \times 10^4 \text{ g of enzymes}$$

- (19) (A). In  $\text{H}_2\text{O}$ , electronegativity difference is highest. So, dipole moment is highest in this.  $\text{CH}_4$  is a symmetrical tetrahedral structure and its dipole moment is zero.

- (20) (A).  $\text{SeF}_4$  and  $\text{XeO}_2\text{F}_2$  are both  $sp^3d$  hybridized, trigonal bipyramidal and see-saw shaped with 1 lone pair of electrons each.

$\text{SF}_4$  has 1 lone pair,  $\text{XeF}_2$  has 3 lone pairs.

$\text{XeOF}_4$  is square pyramidal with 1 lone pair,

$\text{TeF}_4$  is seesaw shaped with 1 lone pair,

$\text{SeCl}_4$  has see-saw shape with 1 lone pair,

$\text{XeF}_4$  has planar shape with 2 lone pairs.

- (21) (C).  $\text{Cu}^+ = 1s^2 2s^2 2p^6 3s^2 3p^6 3d^{10}$ .

Shells occupied = 3, sub-shells occupied = 6, filled orbitals = 14, Unpaired  $e^- = 0$

- (22) (C). There is no restriction that resonating structures should have +ve and -ve charges on atoms that are far apart.

- (23) (B). Let the weight of  $\text{CO} = \text{weight of } \text{CH}_4 = a \text{ g}$

Moles of  $\text{CO} = a/28$

Moles of  $\text{CH}_4 = 16$

$$\text{Total moles} = \frac{a}{28} + \frac{a}{16}$$

$$x_{\text{CH}_4} = \frac{\frac{a}{16}}{\frac{a}{28} + \frac{a}{16}} = \frac{a}{16} \times \frac{28 \times 16}{44a} = \frac{14}{22} = \frac{7}{11}$$

$\therefore$  Fraction of pressure exerted by  $\text{CH}_4 = 7/11$ .

- (24) (D).

(A) It successfully explained the stability of atoms.

(B) It is not in agreement with Heisenberg's uncertainty principle.

(C) It does not explain the spectra of multi-electron atoms.

(D) It does not explain de Broglie concept of the dual character of matter.

- (25) (A). Compound:  $\text{BeCl}_2 > \text{NO}_2 > \text{SO}_2$

Angle:  $180^\circ > 132^\circ > 119.5^\circ$

- (26) (A). In van der Waal's eq., a signifies the intermolecular force of attraction.

- (27) (C). When excess of ammonia reacts with chlorine, nitrogen gas is evolved.

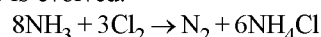

8 part      3 part

In this reaction, the ratio of chlorine to ammonia is 3 : 8.

- (28) (C). For Pfund series,  $n_1 = 5$  and  $n_2 = n_1 + 1 = 6$  (for first spectral line)

$$\bar{\nu} = \frac{1}{\lambda} = R_H Z^2 \left( \frac{1}{n_1^2} - \frac{1}{n_2^2} \right) = R_H \times 1 \left( \frac{1}{(5)^2} - \frac{1}{(6)^2} \right)$$

$$= R_H \times \left( \frac{1}{25} - \frac{1}{36} \right) = \left( \frac{36 - 25}{36 \times 25} \right) R_H = \frac{11 R_H}{900}$$

- (29) (A). The order of bond order is

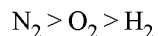

(3)    (2)    (1) bond order

CsCl has bcc lattice and thus each  $\text{Cs}^+$  is surrounded by  $8\text{Cl}^-$  ions.

Ionic nature  $\propto$  size of cation.

$\therefore$  Order of ionic nature is  $\text{KCl} > \text{MgCl}_2 > \text{AlCl}_3$

$\text{PF}_5 \Rightarrow 5\text{bp} + 0\text{lp} = \text{sp}^3\text{d}$  hybridisation

$\text{ClF}_3 \Rightarrow 3\text{bp} + 2\text{lp} = \text{sp}^3\text{d}$  hybridisation

$\text{XeF}_2 \Rightarrow 2\text{bp} + 3\text{lp} = \text{sp}^3\text{d}$  hybridisation

(30) (C). Mass of  $0.25 N_A$  atoms of X is 2.25 gram

$$\text{So, mass of 1 atom is} = \frac{2.25}{0.25N_A} \text{ gram} = 1.5 \times 10^{-23} \text{ g}$$

(31) (B). Molecular weight of air at STP  
 $= 0.001293 \text{ g mL}^{-1} \times 22400 \text{ mL} = 28.7 \text{ g}$

So V.D. =  $28.7/2 \approx 14.3$

(32) (A). Isobars have same mass number.

(33) (C). Number of electrons in subshells =  $2(2\ell + 1)$

(34) (A). For  $n = 8$  to  $n = 6$ , energy difference is minimum and  $\lambda \propto (1/\text{Energy})$

(35) (A).  $Z = 26 \rightarrow [\text{Ar}] 4s^2 3d^6$

$$\sqrt{n(n+2)} = \sqrt{24} \Rightarrow n = 4$$

In d-orbital number of unpaired electron = 4,

but element have charge so 4s electron have to be removed, hence  $n+ = 2$ .

(36) (C).  $V_1 = 100\text{ml}$ ,  $V_2 = 80\text{ml}$ ,  $T_1 = 300\text{K}$ ,  $T_2 = ?$

$P_1 = 740\text{ mm}$ ,  $P_2 = 740\text{ mm}$

Applying charle's law  $V \propto T$

$$\frac{V_1}{T_1} = \frac{V_2}{T_2} \quad ; \quad \frac{100}{300} = \frac{80}{T_2} \Rightarrow T_2 = \frac{300 \times 80}{100} = 240 \text{ K}$$

$$= 240 - 273^\circ\text{C} = -33^\circ\text{C}.$$

(37) (C). Average K.E. for one mole =  $\frac{3}{2}RT$

Average K.E. for 14 g of  $\text{N}_2$   $\left(\frac{1}{2} \text{ mole}\right)$

$$= \frac{3}{2} \times \frac{8.314}{2} \times 400 = 2494 \text{ J}$$

(38) (B). For ideal gas, compressibility factor ( $Z$ ) = 1.

(39) (A).  $\text{CO}_3^{2-}$ : bond length between C - O and C = O (due to resonance) bond length maximum.

$\text{CO}_2$ : bond length shorter than C = O.

$\text{CO}$ : bond order = 3

$\Rightarrow$  Triple bond  $\Rightarrow$  bond length minimum.

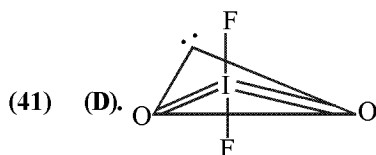
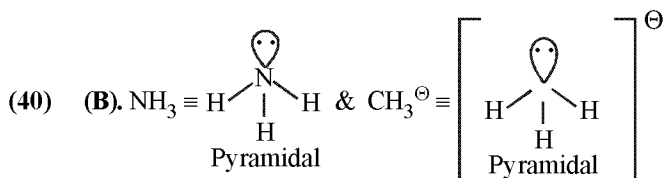

(42) (B).  $\text{O}_2^-$ :  $\text{KK}(\sigma 2s)^2(\sigma^* 2s)^2(\sigma 2p_z)^2(\pi 2p_x)^2 = \pi 2p_y^2$

$$\underbrace{\pi^* 2p_x^1 = \pi^* 2p_y^1}_{\text{HOMO}}$$

(43) (B).  $\text{O}_2^+ = \text{BO} = 2.5 > \text{BOO}_2$   
15 electron

$\therefore$  paramagnetic.

(44) (A). The hybridisation of oxygen in water molecule is  $\text{sp}^3$ . So, water must be tetrahedral and have bond angle  $109^\circ 28'$ . But due to the presence of two lone pair of electrons on oxygen atom (repulsion between lone pair-lone pair) the bond angle decreases about  $104.5^\circ$  and the geometry becomes distorted tetrahedral or V-shaped.

(45) (B). Two ice cubes unite due to H-bond developed between water molecules of two cubes.

(46) (B). You are given a value for the acceleration of the truck; its initial velocity must be zero because it is stopped. The car has a constant velocity, which is given, and therefore its acceleration must be zero.

$a_{\text{truck}} = 2.5 \text{ m/s}^2$ ;  $v_{0,\text{truck}} = 0$ ,  $a_{\text{car}} = 0$ ,  $v_{\text{car}} = 15\text{m/s}$

Also, let the initial position be zero along the x-axis. We want to find the time when the distance from this origin is the same for both the car and the truck.

Recall the kinematic equation  $x = x_0 + v_0t + \frac{1}{2}at^2$ .

You know all of the variables except x and t for both vehicles. Set  $x_{\text{truck}} = x_{\text{car}}$

$$x_{\text{car}} = v_{0,\text{car}}t + \frac{1}{2}a_{\text{car}}t^2 = \left(15 \frac{\text{m}}{\text{s}}\right)t$$

$$= x_{\text{truck}} = v_{0,\text{truck}}t + \frac{1}{2}a_{\text{truck}}t^2 = \frac{1}{2}\left(2.5 \frac{\text{m}}{\text{s}^2}\right)t^2$$

$$\Rightarrow \left(15 \frac{\text{m}}{\text{s}}\right)t = \frac{1}{2}\left(2.5 \frac{\text{m}}{\text{s}^2}\right)t^2 \Rightarrow t = 12 \text{ seconds}$$

Notice that if you needed to figure out where (i.e., the distance at which) the truck caught up with the car, you could put this value for t into either equation and solve for x.

(47) (D). This problem is asking you to add vectors to find a resultant. The first step is to create a diagram and assign axes.

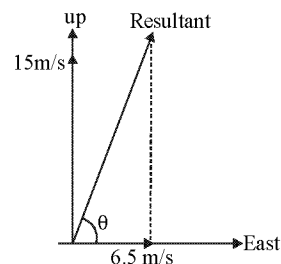

To find the magnitude, use the Pythagorean theorem,  $a^2 + b^2 = c^2$ , where  $a = 15 \text{ m/s}$ ,  $b = 6.5 \text{ m/s}$ , and  $c = \text{resultant}$ .

$$a^2 + b^2 = c^2$$

$$15^2 + 6.5^2 = 267.25 = (\text{magnitude})^2$$

$\Rightarrow$  Magnitude =  $\sqrt{267.25} = 16.35 \text{ m/s}$   
To find the direction, use trigonometry,

$$\tan \theta = \frac{\text{opposite}}{\text{adjacent}} = \frac{15}{6.5} = 2.3 \Rightarrow \theta = \tan^{-1}(2.3) = 66^\circ$$

There are only two significant figures, so the magnitude is 16 m/s. Notice that the angle you found is measured from the horizontal. This angle measured from the vertical would be  $90^\circ - \theta = 24^\circ$ .

- (48) (A). This is an example of projectile motion in which the path of the ball is a parabola that has the same initial and final heights. The question tells you that the total time of flight is 6 seconds. You can also infer that acceleration is due only to gravity because the ball is in free fall. The ball flies in a symmetrical parabola, so it must hit its maximum height halfway through the flight, at a time of 3 seconds.

$$t_0 = 0, t_{\text{flight}} = 6 \text{ seconds}, a = -g, t_{\text{top}} = 3 \text{ seconds}$$

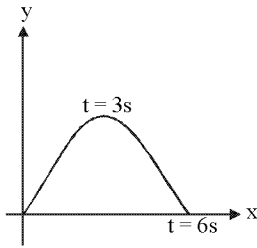

There is not enough information to plug into one of the kinematic equations and simply solve for the maximum height. It would be helpful to know the initial

velocity. Recall  $y = y_0 + v_0 t - \frac{1}{2} g t^2$ .

Let the initial height equal zero, which implies that the final height is also zero.

$$y_0 = 0, y_f = 0$$

$$y_f = y_0 + v_0 t_f - \frac{1}{2} g t_f^2$$

$$= 0 + v_0(6s) - \frac{1}{2} \left( 9.81 \frac{\text{m}}{\text{s}^2} \right) (6s)^2 = 0$$

$$\Rightarrow v_0 = 29.43 \text{ m/s}$$

Now use the same equation to solve for the height at the top, halfway through the flight.

$$y_{\text{top}} = y_0 + v_0 t_{\text{top}} - \frac{1}{2} g t_{\text{top}}^2$$

$$y_{\text{max}} = 0 + 29.43 \frac{\text{m}}{\text{s}} \times 3s - \frac{1}{2} \left( 9.81 \frac{\text{m}}{\text{s}^2} \right) (3s)^2 = 44 \text{ m}$$

$$\text{Alt: } \frac{u \sin \theta}{g} = 3, h_{\text{max}} = \frac{u^2 \sin^2 \theta}{2g} = 44 \text{ m}$$

- (49) (D). A free-body diagram illustrates this problem best.

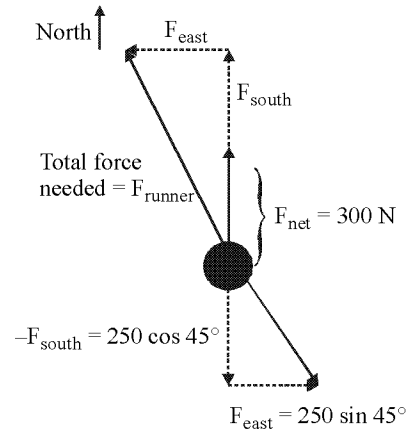

To find the amount of force needed to combat the wind, first resolve the wind into its south and east components. Since the wind is blowing exactly 45 degrees east of south,

$$F_{\text{south}} = F_{\text{east}} = 250 \cos 45^\circ = 176.778 \text{ N.}$$

To accelerate due north at the desired acceleration, the runner must counteract the wind force. To find the amount of force needed to accelerate a 150 kg person at  $a = 2 \text{ m/s}^2$  north, invoke Newton's second law.

$$\vec{F} = m\vec{a}, \text{ where } \vec{a} = 2 \frac{\text{m}}{\text{s}^2} \text{ and } m = 150 \text{ kg}$$

$$\vec{F}_{\text{net (N/s)}} = (150 \text{ kg}) \left( 2 \frac{\text{m}}{\text{s}^2} \right) = 300 \text{ N north}$$

The total northern component of the force is  $300 + 176.778 = 476.778 \text{ N}$ .

The total western component of the force is 176.778 N. Therefore, the total force is

$$F_{\text{net}} = \sqrt{(300)^2 + (176.778)^2} = 508 \text{ N.}$$

The direction  $\theta = \tan^{-1} \left( \frac{176.778}{476.778} \right) = 20^\circ$  west of north

- (50) (A). Begin by drawing a picture, then create a free-body diagram from your sketch.

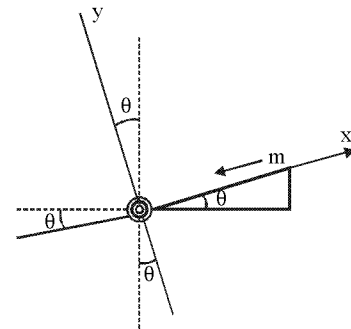

In this picture, the door, represented by the thick line, is an incline plane with an angle  $\theta$  at the hinge. The axis is arbitrary; here it is in line with the direction the block will slide. By using the geometric rules for opposite angles, you can find the angle made with the force of gravity.

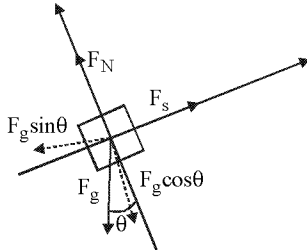

In this free-body diagram, treat the block as a point mass. The axes have been moved, but they are parallel to those in the picture. This allows you to find the components of the force from gravity.

You want to find the coefficient of static friction as the

block starts to move. This is defined as  $\mu_{\max} = \frac{\vec{F}_s}{\vec{F}_N}$ .

Therefore, you first must find both the normal force and the force of static friction.

The normal force is the force that is perpendicular to the surface. In other words, it opposes the y-component of the force of gravity. The force of static friction is the force needed to hold the object in place, opposing the x component of gravity.

$$\vec{F}_g = -mg, \vec{F}_{g,y} = -mg \cos \theta, \vec{F}_{g,x} = -mg \sin \theta$$

where  $m = 2 \text{ kg}$ ,  $g = 9.81 \text{ m/s}^2$ ,  $\theta = 30^\circ$

$$\vec{F}_N = -\vec{F}_{g,y} = mg \cos \theta, \vec{F}_s = -\vec{F}_{g,x} = mg \sin \theta$$

$$\Rightarrow \mu_s = \frac{\vec{F}_s}{\vec{F}_N} = \frac{mg \sin \theta}{mg \cos \theta} = \tan \theta = 0.577$$

- (51) (A). Because the child is being pulled at a constant velocity, there is no acceleration. This means that you are dealing with an equilibrium situation.

In order for the wagon not to be lifted off the ground, the vertical component of the force plus the normal force  $N$  exerted by the ground on the wagon must equal the downward force exerted by the child and wagon (150 N).

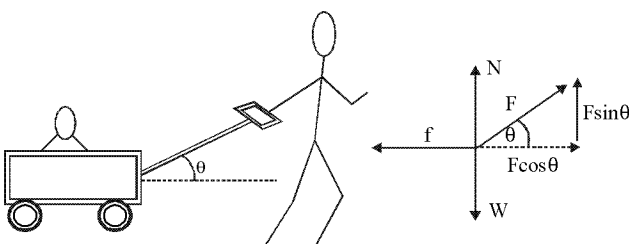

Solve for the vertical component:  $F \sin(45^\circ) + N = 150$ , but  $N = f/\mu$ , where  $f$  is the frictional force and  $\mu$  is the coefficient of kinetic friction.

The horizontal component must equal the force of friction to prevent the wagon from accelerating:

$$f = F \cos(45^\circ) \text{ or } F = \frac{f}{\cos(45^\circ)}. \text{ Combine:}$$

$$\frac{f}{\cos 45^\circ} \sin 45^\circ + \frac{f}{\mu} = 150 \Rightarrow f \left( \tan 45^\circ + \frac{1}{\mu} \right) = 150$$

Since,  $\tan 45^\circ = 1$  and  $1/\mu = 5$ ,

You get,  $6f = 150$  or  $f = 25 \text{ N}$

- (52) (A). To find the time it takes to move a certain distance, you must first find the acceleration. You can do this by using Newton's second law,  $\Sigma F = ma$ , along the x-axis,

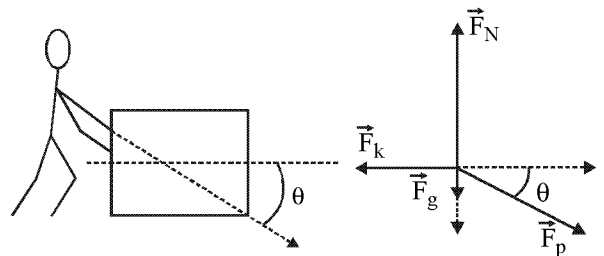

$$\Sigma \vec{F}_x = m\vec{a} = \vec{F}_{p,x} - \vec{F}_k = \vec{F}_p \cos \theta - \vec{F}_k$$

To use the definition for kinetic friction,  $\vec{F}_k = \mu_k \vec{F}_n$ ,

we must first find  $\vec{F}_n$ .

Be sure to include the y-component of the force of the push when finding the normal force; the normal force increases as additional vertical force against the surface is added.

$$\vec{F}_N = mg + \vec{F}_p \sin \theta, \quad mg = 300 \text{ N} \Rightarrow m = \frac{300}{9.81} \text{ kg}$$

$$\text{Now, } \vec{a} = \frac{\vec{F}_p \cos \theta - \mu_k (mg + \vec{F}_p \sin \theta)}{m},$$

where  $\vec{F}_p = 500 \text{ N}$ ,  $\theta = 35^\circ$ ,  $\mu_k = 0.57$ ,  $m = 30.6 \text{ kg}$ ,

$$\vec{a} = 2.454 \text{ m/s}^2.$$

This can now be substituted into the kinematic equation for constant position, which is solved for

$$\text{time. } x = x_0 + v_0 t + \frac{1}{2} a t^2, \text{ where } x_0 = 0, v_0 = 0$$

$$\Rightarrow t^2 = \frac{2x}{a}, \quad t = \sqrt{\frac{2x}{a}}, \text{ where } x = 4.00 \text{ m}, a = 2.454 \text{ m/s}^2$$

So,  $t = 1.80 \text{ s}$

- (53) (C). The rope is being pulled down, but the force will be directed up the slope because of the pulley.

Therefore, you merely need to find the force along the slope needed to hold the block in equilibrium.



A free-body diagram illustrates that this force must counteract the force of gravity on the object but it has the help of static friction.

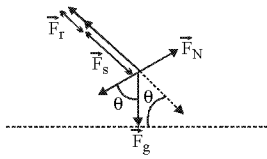

$$\Sigma \vec{F}_{\text{slope}} = 0 = \vec{F}_r + \vec{F}_s - \vec{F}_g \sin \theta,$$

where  $\vec{F}_s = \mu_s \vec{F}_g \cos \theta$  and  $\vec{F}_g = mg$

$$\Rightarrow \vec{F}_r = mg \sin \theta - \mu_s mg \cos \theta = mg (\sin \theta - \mu_s \cos \theta)$$

- (54) (B). The information given is  $s = d$  and  $v_0 = v$ . You are looking for the coefficient of kinetic friction,  $F_k = \mu_k F_N$ , so you will need to find the normal force. Because the only force working on the block is gravity,  $\vec{F}_N = mg$ . The only force working in the horizontal direction is friction, so  $F_k = \mu_k F_N = ma = -\mu_k mg$   
 $\Rightarrow a = -\mu_k g$ .

Now you can use the kinematic equation for constant acceleration.  $v^2 = v_0^2 + 2as$ , at rest,  $v = 0$

$$\Rightarrow 0 = v^2 - 2\mu_k gd \Rightarrow \mu_k = \frac{v^2}{2gd}$$

- (55) (C). This problem is another projectile motion problem in which you can use symmetry because the initial and final heights are the same. It can be derived that the range of a projectile

$$x_{\text{max}} = \frac{2v_0^2 \sin \theta \cos \theta}{g} = \frac{v_0^2 \sin 2\theta}{g}$$

You are given the launch angle and range, so the only unknown variable is the initial velocity.

Be sure to convert all units so that they are the same. This is easiest when done before you start plugging values into equations. You can see that the answer choices are in m/s, so we know we want our range in meters.  $x_{\text{max}} = 15 \text{ km} = 15,000 \text{ m}$ ,  $\theta = 45^\circ$

Solve for initial velocity.

$$v_0^2 = \frac{gx}{\sin 2\theta} = \frac{9.81 \frac{\text{m}}{\text{s}^2} \times 15,000 \text{ m}}{\sin 90^\circ} = 147,150 \frac{\text{m}^2}{\text{s}^2}$$

$$\Rightarrow v_0 = \sqrt{147,150 \frac{\text{m}^2}{\text{s}^2}} = 383.6 \frac{\text{m}}{\text{s}}$$

- (56) (D). Newton's second law is most often stated as  $F = ma$ . Choice (A). However, it can also be written as  $F = dp/dt$ , where  $p$  is the momentum, choice (B).

For constant mass,  $\frac{dp}{dt} = m \frac{dv}{dt}$ , so (C) is also correct.

All of the choices are correct.

- (57) (A). The average acceleration is given by the change in velocity divided by the change in time:  $a = \Delta v / \Delta t$ . The velocity is given by the change in position (not total distance traveled) over time. Acceleration, velocity, and position are all vectors, so we are looking at net change in position. Since the location is the same at start and finish, the net change in position is zero. Hence, the average acceleration is zero.
- (58) (D). Start with a free-body diagram as shown.

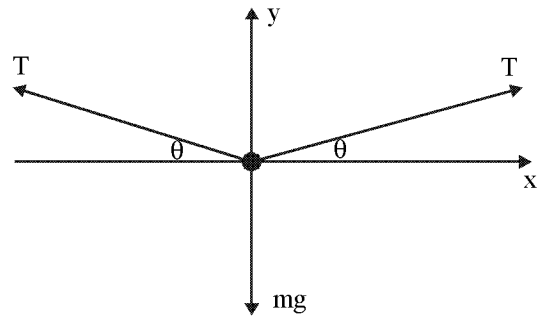

The three forces are the downward weight of the person,  $mg$ , and the tensions,  $T$ , on the rope on either side of the person. There is no acceleration in this case (unless the rope breaks), so both the  $x$  components and the  $y$  components of the forces sum to zero:

$$\Sigma F_x = 0 \quad \text{and} \quad \Sigma F_y = 0$$

If the person is at the center of the rope, the rope's angle,  $\theta$  from the horizontal will be the same on both sides. In this case, summing the  $x$  components of the forces tells us that the tension,  $T$  will be the same on both sides of the rope. You may have guessed this intuitively. Summing the  $y$  components of both tensions and the person's weight,  $mg$ , and setting the sum equal to zero gives us

$$\Sigma F_y = T \sin \theta + T \sin \theta - mg = 0$$

Solving this equation for  $T$  gives us

$$T = \frac{mg}{2 \sin \theta}$$

Notice that this tension can be much larger than the person's weight, especially if the angle is small.

- (59) (D). The instantaneous speed is defined as the object's speed at a given time  $t$ . It can be determined by taking the first derivative with respect to time of the function that represents the particle's displacement:

$$v(t) = \frac{dx}{dt}, \quad \text{where } x \text{ is the particle's displacement.}$$

Taking the derivative of  $x = 5t + 9t^3$  with respect to time

$$\text{yields } v(t) = \frac{dx}{dt} = \frac{d}{dt}(5t + 9t^3) = 5 + 27t^2$$

- (60) (B). The instantaneous acceleration at some time  $t$  can be determined by taking the first derivative with respect to time of the function that represents the particle's instantaneous speed.

$$a(t) = \frac{dv}{dt}$$

For this situation,  $v(t) = 5 + 27t^2$ .

Substituting this into the following yields

$$a(t) = \frac{dv}{dt} = \frac{d}{dt}(5 + 27t^2) = 54t$$

We are asked to evaluate this at a specific time.

Therefore, at  $t = 2s$ , we would get

$$a(2) = 54(2) = 108 \text{ m/s}^2$$

- (61) (B). The acceleration of the masses in the system can be determined by examining the forces that are acting upon each of the masses. Mass 1 has the force of its weight  $m_1g$  pulling downward at the same time that the force of string tension  $T$  is pulling it upwards. This mass is also accelerating upwards by the resultant force  $m_1a$ . These forces on mass 1 are related to each other as follows:

$$(1) T - m_1g = m_1a$$

The mass sliding on the inclined plane, mass 2, has a component of its weight  $m_2g \sin \theta$  pulling it down the incline while the string tension  $T$  is pulling in the opposite direction. This mass is accelerating down the inclined plane with an acceleration also given by  $a$ . It follows that these forces on mass 2 are related to each other by the following

$$(2) m_2g \sin \theta - T = m_2a$$

We can solve (1) and (2) for  $T$  and get the following:

$$T = m_1a + m_1g = m_2g \sin \theta - m_2a$$

Let's rearrange this equation by placing all of the expressions that involve  $a$  on the left and those involving  $g$  on the right.

$$m_1a + m_2a = m_2g \sin \theta - m_1g$$

$$a(m_1 + m_2) = g(m_2 \sin \theta - m_1)$$

Therefore, the acceleration of the masses is

$$a = \frac{m_2g \sin \theta - m_1g}{m_1 + m_2}$$

- (62) (C). We can use the results from the previous problem to help us solve this one. By considering the forces acting upon mass 1, we determined that these forces are related to one another by  $T - m_1g = m_1a$

This means that the string tension  $T$  is

$$T = m_1g + m_1a = m_1(g + a)$$

Substituting the relationship we found for the acceleration of the two masses

$$a = \frac{m_2g \sin \theta - m_1g}{m_1 + m_2}$$

into this equation gives

$$T = m_1(g + a) = m_1 \left( \frac{g + (m_2g \sin \theta - m_1g)}{m_1 + m_2} \right)$$

Simplifying this yields

$$T = \frac{m_1m_2g \sin \theta - m_1^2g + m_1^2g + m_1m_2g}{m_1 + m_2}$$

$$= m_1m_2g \frac{(1 + \sin \theta)}{m_1 + m_2}$$

Therefore, the string tension is

$$T = m_1m_2g \frac{(1 + \sin \theta)}{m_1 + m_2}$$

- (63) (C). Acceleration =  $\frac{d^2x}{dt^2}$

For part OP, the acceleration is positive as the velocity is increasing. Slope is increasing. For part PQ, the acceleration is zero. Horizontal straight line shows that the velocity is zero. For part QR, acceleration is negative. It is retarded motion. Velocity is decreasing as the slope decreases with time.

- (64) (B). After 0.7 sec the horizontal velocity component of the body =  $4\sqrt{2}$  m/sec since there is no change in velocity in horizontal direction.

The vertical velocity component after 0.7 seconds

$$= 0 + gt = 0 + 0.7 \times 10 = 7 \text{ m/sec}$$

∴ Resultant velocity of the body

$$= \sqrt{(4\sqrt{2})^2 + 7^2} = \sqrt{32 + 49} = 9 \text{ m/sec.}$$

- (65) (D). Three equal weights of 3 kg each are hanging on a string passing over a pulley as shown in figure.

If  $a$  is the common acceleration.

$$T - 3g = 3a \quad (\text{For mass I})$$

$$3g + T_1 - T = 3a \quad (\text{For mass II})$$

$$3g - T_1 = 3a \quad (\text{For mass III})$$

Adding, above three equations

$$3g = 9a, a = g/3$$

$$T_1 = 3g - 3a = 3g - g = 2g = 20 \text{ N}$$

- (66) (A).  $E = G^p h^q c^r$  ..... (1)

$$[M^1L^2T^{-2}] = [M^{-1}L^3T^{-2}]^p [ML^2T^{-1}]^q [LT^{-1}]^r$$

$$= M^{p+q} L^{3p+2q+r} T^{-2p-q-r}$$

Applying principle of homogeneity of dimensions, we

$$\text{get } -p + q = 1 \quad \text{..... (2)}$$

$$3p + 2q + r = 2 \quad \text{..... (3)}$$

$$-2p - q - r = -2 \quad \text{..... (4)}$$

Add (3) and (4),

$$p + q = 0 \quad \text{..... (5)}$$

Add (2) and (5), we get  $q = 1/2$

$$\text{From (ii), we get } p = q - 1 = \frac{1}{2} - 1 = -\frac{1}{2}$$

$$\text{Put in (iii), we get } -\frac{3}{2} + 1 + r = 2, r = 5/2$$

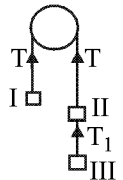

- (67) (B). The kinetic energy of the projectiles is maximum at the point of release. The ratio of K.E. of projectiles

$$\frac{\frac{1}{2} m u_1^2}{\frac{1}{2} m u_2^2} = \frac{4}{1} \Rightarrow \frac{u_1^2}{u_2^2} = \frac{4}{1} \quad \dots(i)$$

The ratio of maximum heights of projectiles

$$\frac{H_1}{H_2} = \frac{4}{1}$$

$$\frac{\frac{u_1^2 \sin^2 \theta_1}{2g}}{\frac{u_2^2 \sin^2 \theta_2}{2g}} = \frac{4}{1} ; \frac{u_1^2 \sin^2 \theta_1}{u_2^2 \sin^2 \theta_2} = \frac{4}{1}$$

$$\frac{4 \sin^2 \theta_1}{1 \sin^2 \theta_2} = \frac{4}{1} \quad (\text{from equation (i)})$$

$$\sin^2 \theta_1 = \sin^2 \theta_2$$

$$\theta_1 = \theta_2$$

Now, ratio of ranges of projectiles

$$\frac{R_1}{R_2} = \frac{u_1^2 \sin 2\theta_1}{u_2^2 \sin 2\theta_2}$$

$$\frac{R_1}{R_2} = \frac{u_1^2 \sin 2\theta_1}{u_2^2 \sin 2\theta_1} \quad (\because \theta_1 = \theta_2)$$

$$\frac{R_1}{R_2} = \frac{u_1^2}{u_2^2} = \frac{4}{1}$$

- (68) (A). Here,  $m = 0.2 \text{ kg}$ ,  $u = 0$

$$\vec{F} = (0.3\hat{i} - 0.4\hat{j}) ; \vec{v} = ?, t = 6\text{s}$$

$$\vec{a} = \frac{\vec{F}}{m} = \frac{(0.3\hat{i} - 0.4\hat{j})}{0.2} = \left( \frac{3}{2}\hat{i} - 2\hat{j} \right)$$

$$\text{From } \vec{v} = \vec{u} + \vec{a} t$$

$$\vec{v} = 0 + \left( \frac{3}{2}\hat{i} - 2\hat{j} \right) \times 6 = 9\hat{i} - 12\hat{j}$$

- (69) (A). The free body diagram of the given situation is

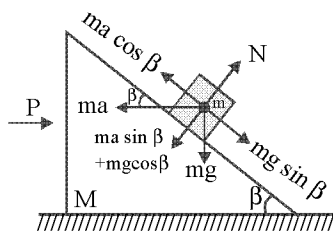

Force = Mass  $\times$  Acceleration

$$\therefore P = (M + m) a$$

$$m a \cos \beta = m g \sin \beta$$

$$\Rightarrow a = g \frac{\sin \beta}{\cos \beta} = g \tan \beta$$

$$\therefore P = (M + m) g \tan \beta$$

(70) (B).  $T_1 = \frac{2u \sin \theta}{g}$  and  $T_2 = \frac{2u \cos \theta}{g}$

$$T_1 T_2 = \frac{2u^2 \sin \theta \cos \theta}{g} = \frac{2r}{g} \quad \left[ \because r = \frac{v^2 \sin 2\theta}{g} \right]$$

- (71) (B). Let  $\ell'$  part of the chain is hanging over the edge of table without sliding.

$$\therefore \mu = \frac{\text{Length hanging over the edge}}{\text{Length lying on the table}}$$

(As the chain have uniform linear density)

$$\therefore \mu = \frac{\ell'}{L - \ell'} \Rightarrow \ell' = \frac{\mu L}{1 + \mu}$$

- (72) (B). Dimension of  $a$  = Dimension of  $F$

$$[a] = [F]$$

$$[a] = \left[ \frac{F}{t} \right] = \left[ \frac{MLT^{-2}}{T} \right] = [MLT^{-3}]$$

Dimension of  $bt^2$  = Dimension of  $F$

$$[bt^2] = [F]$$

$$[b] = \left[ \frac{F}{t^2} \right] = \left[ \frac{MLT^{-2}}{T^2} \right] = [MLT^{-4}]$$

- (73) (B). The time =  $2 \text{ min } 20 \text{ s} = 2 \text{ min} + 20 \text{ s}$   
 $= 2 \times 60\text{s} + 20\text{s} = 140\text{s}$

In 40 s athlete completes = 1 round

In 140 s athlete will completes

$$= \frac{140}{40} \text{ round} = \frac{120}{40} + \frac{20}{40} = 3 + \frac{1}{2} \text{ round}$$

The displacement in 3 round = 0

So displacement in  $\frac{1}{2}$  round =  $AB = 2R$

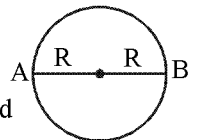

- (74) (C).  $\vec{r} = 2 \sin \left( \frac{\pi}{4} \right) t \hat{i} + 2 \cos \left( \frac{\pi}{4} \right) t \hat{j} + 3t \hat{k}$

$$\text{Velocity} = \vec{v} = \frac{\pi}{2} \cos \left( \frac{\pi}{4} \right) t \hat{i} - \frac{\pi}{2} \sin \left( \frac{\pi}{4} \right) t \hat{j} + 3\hat{k}$$

$$\text{Speed} = |\vec{v}| = \sqrt{\left( \frac{\pi}{2} \cos \frac{\pi}{4} t \right)^2 + \left( -\frac{\pi}{2} \sin \frac{\pi}{4} t \right)^2 + 9}$$

$$\text{Speed} = v = \sqrt{\frac{\pi^2}{4} + 9} ; \frac{dv}{dt} = 0$$

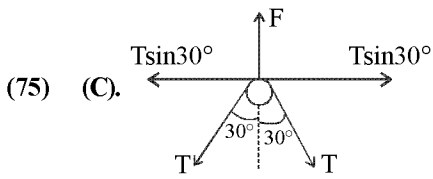

$$2T \cos 30^\circ = F$$

$$2T \frac{\sqrt{3}}{2} = F \Rightarrow T = \frac{F}{\sqrt{3}}$$

(76) (C). Distance covered in last second

$$7h = 0 + \frac{g}{2}[2t-1] \quad \dots\dots (1)$$

Distance covered in first second

$$h = 0 + \frac{1}{2} \times g \times 1^2 = \frac{g}{2} \quad \dots\dots (2)$$

Put in eq. (1),  $\frac{7g}{2} = \frac{g}{2}(2T-1)$  ;  $2T = 8$  ;  $T = 4s$

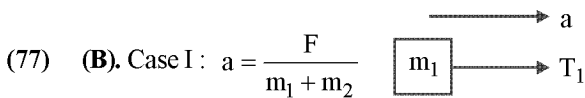

$$T_1 = \frac{m_1 F}{m_1 + m_2} \quad \dots\dots (1)$$

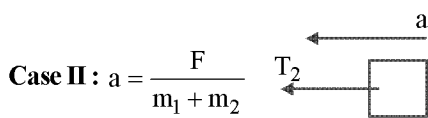

$$T_2 = \frac{m_2 F}{m_1 + m_2} \quad \dots\dots (2)$$

$$\frac{T_1}{T_2} = \frac{m_1}{m_2} \text{ . So } T_1 < T_2$$

(78) (C).  $\langle \vec{V} \rangle = \frac{\vec{V}_1 + \vec{V}_2}{2}$

$$= \frac{(10 \cos 37^\circ \hat{i} + 10 \sin 37^\circ \hat{j}) + (10 \cos 37^\circ \hat{i})}{2} = 8\hat{i} + 3\hat{j}$$

(79) (A). Motion of stone with respect to mango is directly towards mango. So, they will collide.

(80) (C).  $S = \frac{1}{2} 4 (10)^2 = 200m$

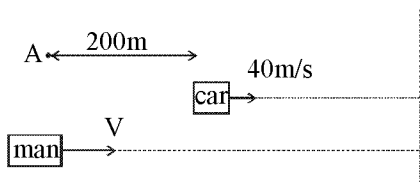

$$V = u + at = 4 \times 10 = 40 \text{ m/s}$$

$$S_{\text{man}} = 200 + S_{\text{car}}$$

$$Vt = 200 + 40t + \frac{1}{2} 4 (t)^2 \quad \dots\dots (1)$$

For man to be able to catch the car, there must be real solution for time, in the equation (1)

Hence,  $t \geq 0$  ;  $V = 80 \text{ m/s}$

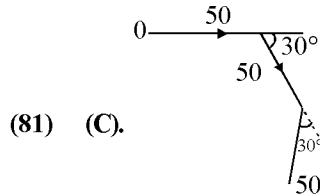

No. of vectors added =  $360^\circ/30^\circ = 12$

Each of length 50m

Total length =  $50 \times 12 = 600 \text{ m}$ .

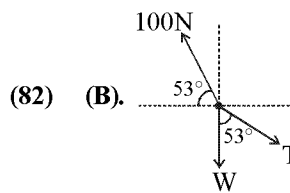

$$T \sin 53^\circ - 100 \cos 53^\circ = 0 \Rightarrow T = 75 \text{ N}$$

Also,  $100 \sin 53^\circ - T \cos 53^\circ - W = 0$

$$\Rightarrow W = 35 \text{ N}$$

(83) (D).  $\tan \theta = \frac{u}{v} = \frac{10}{10/\sqrt{3}} = \sqrt{3}$

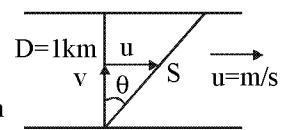

$$S = \frac{D}{\cos \theta} = \frac{1 \text{ km}}{\cos 60^\circ} = 2 \text{ km}$$

(84) (B). At  $t = 1s$ ,  $\theta = 45^\circ$

$$V_{\text{sep}} = 3 \cos \theta + 4 \sin \theta = 3 \frac{1}{\sqrt{2}} + 4 \frac{1}{\sqrt{2}} = \frac{7}{\sqrt{2}}$$

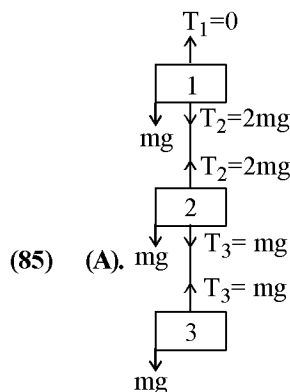

Just after string is cut tension in spring remains unchanged, hence second and third block has zero acceleration.

(86) (C).  $F_{\text{max}} = 4 \times 2 + 2 \times 2 = 12 \text{ N}$

$$F_{\text{min}} = 4 \times 2 - 2 \times 2 = 4 \text{ N}$$

So, 16 N is not possible

- (87) (C). Both blocks move together  
 $(m_1 + m_2) a = F - \mu (m_1 + m_2) g$

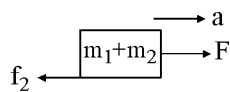

$$a = \frac{F - 32}{8} \text{ m/s}^2$$

$$m_1 a = f_1$$

$$3 \times \frac{F - 32}{8} = 0.4 \times 3g$$

$$F = 64 \text{ N}$$

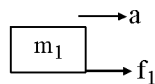

- (88) (C). The F.B.D. of section of rope between A and B having acceleration  $a$  towards left is

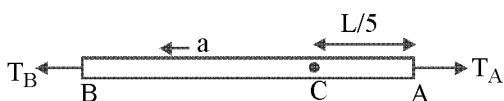

Applying Newton's second law on section AB and section AC of rope we get

$$T_B - T_A = Ma \quad \text{and} \quad T_C - T_A = \frac{M}{5} a$$

$$\text{Solving } T_C = \frac{T_B + 4T_A}{5}$$

- (89) (D). Net displacement = 0  
 Total distance = OP + PQ + QO

$$= \left( 1 + \frac{2\pi \times 1}{4} + 1 \right) \text{ km} = 3.57 \text{ km}$$

$$V_{av} = \frac{3.57}{10/60 \text{ hour}} = 21.42 \text{ km/hr}$$

- (90) (A). The dimensions of given fundamental quantities are given below:

$$\text{Energy (E)} = [ML^2T^{-2}]$$

$$\text{Velocity (v)} = [LT^{-1}]$$

$$\text{Time (T)} = [T]$$

and surface tension  $[S] = [MT^{-2}]$

$$\text{Let } [S] \propto [E]^a \times [v]^b \times [T]^c$$

$$[S] = k [E]^a \times [v]^b \times [T]^c$$

Putting the dimensions of both sides, we have

$$[MT^{-2}] = [ML^2T^{-2}]^a \times [LT^{-1}]^b \times [T]^c$$

$$[ML^0T^{-2}] = [M]^a \times [L]^{2a+b} \times [T]^{-2a-b+c}$$

Comparing the powers of both sides, we have

$$a = 1; \quad 2a + b = 0; \quad -2a - b + c = -2$$

So, we get  $a = 1$ ,  $b = -2$  and  $c = -2$

Hence the dimensional formula for surface tension is

$$T = [E v^{-2} T^{-2}]$$

- (91) (C). The Protista are classified by mode of locomotion. Paramecia move by cilia, amoeba move by pseudopods, and euglena move by means of a flagellum.

- (92) (A). The kingdom Protista consist of the most varied organisms of any kingdom. However, one thing all Protista have in common is that they are all eukaryotes.

- (93) (D). *Thermococcus*, *Methanococcus* & *Methanobacterium* exemplify archaebacteria that lack any histones resembling those found in eukaryotes but whose DNA is negatively supercoiled. Archaebacteria do not have a nucleus, the genetic material floats freely in the cytoplasm. They consist of ribosomal RNA. DNA contains a single, circular molecule, which is compact and tightly wound. No protein is associated with DNA. The archaebacterial cell may contain plasmids, which are small, circular pieces of DNA and have a highly negatively supercoiled DNA.

- (94) (D). Unlike *Cycas* and *Pinus*, *Gnetum* shows the occurrence of vessel elements and the absence of archegonia. Archegonia are altogether absent in the female gametophyte and vessels occur in the xylem along with the tracheids in the secondary wood. Thus *Gnetum* shows affinities with angiosperms. Besides it resembles angiosperms in several other aspects like presence of tetrasporic embryo sac, free nuclear divisions in the embryo sac, two cotyledonous embryo etc.

- (95) (C). The common peafowl or peacock, *Pavo cristatus*, called 'Mor' or 'Mayur' in hindi, is the national bird of India. It occurs throughout India upto 1650 meters in the himalayas. It displays a well-marked sexual dimorphism, the male having a gorgeous ocellated tail.

- (96) (B). Mycoplasma are the smallest and simplest free living Gram negative prokaryotes or monerans. A cell wall is absent. Plasma membrane forms the outer boundary of the cell. A substantial amount of polysaccharides having acetyl glucosamine are associated with cell membrane.

- (97) (A). Sexual reproduction in Spirogyra takes place by the process of conjugation. In Spirogyra, the process of conjugation may be of two types-scalariform conjugation and lateral conjugation. Scalariform conjugation occurs in heterothallic species. Lateral conjugation occurs between the adjacent cells of the same filament of homothallic species of Spirogyra. Lateral conjugation are of two types. They are indirect lateral conjugation (chain type) and direct lateral conjugation.

- (98) (D). Being eukaryotes, the protistan cell body contains a well defined nucleus and other membrane-bound organelles. It is surrounded by plasmalemma (cell membrane). Cilia and flagella occur in a number of forms. Nucleus has typical structure-porous nuclear envelope, chromatin, nucleolus and nucleoplasm. Monerans lack nuclear membrane.

- (99) (B). *Panthera tigris* - Tiger  
*Mangifera indica* - Mango  
*Musca domestica* - Housefly  
*Periplaneta americana* - Cockroach  
*Rana tigrina* - Common Indian frog

- (100) (A). In pteridophytes, the main plant body is a sporophyte which is differentiated into true root, stem and leaves and gametophyte is small or inconspicuous, it is usually independent.
- (101) (C).
- (102) (D). The most obvious and technically complicated feature of all living organisms is their ability to sense their surroundings or environment and respond to these environmental stimuli which could be physical, chemical or biological.
- (103) (B). In mosses the sporophytes (i.e. the diploid body) are short-lived and dependent on the gametophyte. In the presence of water, sperms from the antheridia swim to the archegonia and fertilization occurs, leading to the production of a diploid sporophyte. The sperm of mosses is biflagellate, i.e. they have two flagella that aid in propulsion. Since the sperms must swim to the archegonium, fertilization cannot occur without water.
- (104) (D). The main criteria for classification used by Whittaker includes cell structure, thallus organization, mode of nutrition, reproduction and phylogenetic relationships. So, the absence of cell wall is one of the main characteristics of animal kingdom.
- (105) (B) (106) (D)
- (107) (B). Snake is *uricotelic*.
- (108) (C). Thallophyta and bryophyta are non vascular plants. Pteridophyta are also known as vascular cryptogams.
- (109) (A). Basidium is formed by fusion of somatic cells known as plasmogamy.
- (110) (A). The Central National herbarium has about one million plant specimens.
- (111) (A). Algae have a haplontic life cycle in which the zygote is the only diploid stage.
- (112) (C). Porifera shows cellular organisation of body, whereas annelids, Platyhelminthes and urochordates shows organ level organisation.
- (113) (D). Earthworm-Annelid-Phylum  
Frog-Rana-Genus  
Lancelet-Protochordata-division
- (114) (C). Ornithorhynchus (Platypus) is egg laying mammal.
- (115) (D). Pleurobrachia belongs to ctenophore, whereas Adamsia (sea anemone), *Astraea*, *Physalia* (Portuguese man of war) belongs to cnidaria.
- (116) (C). Oyster mushroom (*Pleurotus osteratus*) is an edible fungus. *Tolyposporium penicillarie* causes smut of bajra. Characteristic spore balls are produced by the fungus and sorus lack the columella. *Colletotrichum falcatum* causes red rot of sugarcane. The mycelium is internal, septate and branched.
- (117) (C). Sub-division—Eumycotina (higher fungi) have class—Ascomycetes (commonly called, sac fungi). The spores of the sexual stage (meiospores) known as ascospores are endogenous in origin. They are produced within sac-like structure called, asci, which vary in shape, e.g., *Morchella* (morels), *Saccharomyces*, *Aspergillus* and *Penicillium*.

The mushrooms (*Agaricus*) belong to club fungi (Basidiomycotina). The edible fleshy fungi are called, the mushrooms.

- (118) (A). There are three different types of system classification, the artificial, the natural and phylogenetic classification
- (a) **Artificial system** : The best known artificial system of Linnaeus published in 1735.
- (b) **Natural system** : Bentham and Hooker's system (1862-83).
- (c) **Phylogenetic system** : Classification proposed by Engler in 1886, by Hutchinson in 1926 and by Tippo in 1942 are phylogenetic.
- (119) (B). A process of nuclear reorganization in *Paramecium aurelia* resembling conjugation but taking place within a single individual is called as autogamy or self conjugation by W.F. Duller (1936). Cytogamy is reported in *Paramecium caudatum* by R. Wichterman (1940). This is a sexual process without nuclear exchange.
- (120) (A). The sexual reproduction in *Spirogyra* is accomplished by conjugation. It is of two types, i.e., scalariform and lateral conjugation. The gametes of *Spirogyra* are distinguishable by their degree of motility. This difference in behaviour is called **physiological anisogamy**. Sexual reproduction in *Ulothrix* is isogamous type. The fusion takes place between gametes of one filament with those of the other having a different genetic constitution. Sexual reproduction in *Volvox* is of advanced type, i.e., with well developed **oogamy**. The male gametangia (gamete bearing) are called antheridia or androgonia, while the female oogonia.
- (121) (B). The yeasts are unicelled, non-mycelial, holocarpic, saprophytic organisms found in sugary media, soil, air on decaying vegetables and fruit. The plant body of *Penicillium* is mycelial. The mycelium is septate and branched. The cells are thin walled and uni to multinucleate. It is saprophytic fungus, which grows on food products and cheese, etc.

- (122) (B).

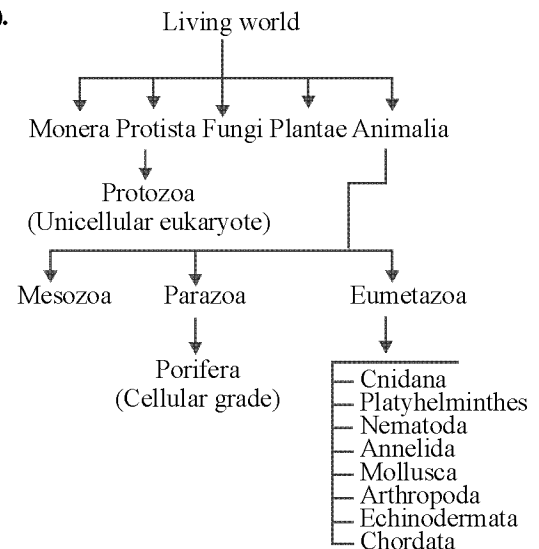

- (123) (D). National park is area strictly reserved for protection and betterment of wildlife and maintenance of ecosystems.  
*Rhinoceros* is protected in Kaziranga National Park.  
 Tuskiess male elephants are also protected in Kaziranga National Park.  
 Lion is protected in Gir National Park.  
 Tiger is protected in Corbett National Park.
- (124) (B). Phylum—Mollusca is the second largest phylum of animals. These are mostly aquatic, triploblastic, coelomate animals with organ system level of organization. In these the true coelom is reduced but spaces between viscera grow and form a large cavity called haemocoel.
- (125) (B). The scorpions are the oldest known terrestrial arthropods, about 800 species have been described, some common genera are *Palamnaeus*, *Buthus*, etc. All scorpions are viviparous and the females carry the young ones on their backs for sometime, for about a week.
- (126) (D). Five-kingdom system of classification was proposed by R.H. Whittaker (1969). This classification was based on presence or absence of nucleus, cell organelles, body organization, mode of nutrition and reproduction. It does not take into account the gradual evolution of distinct plant and animal groups and Gram staining.
- (127) (A). Angiosperms are most diverse and wide spread of all plant groups. There are about 3,00,000 species of flowering plants on earth. Their dominance is due to power of adaptability in diverse habitat.
- (128) (A). The contractile vacuole disappears.  
 Because, it does conserve water and does not eliminate water.
- (129) (D). Species – genus – family – order – class – phylum – kingdom.
- (130) (C).
- (131) (B). It is microscopic
- (132) (A).
- (133) (C). Carry out oxygenic photosynthesis.
- (134) (A).
- (135) (A). Mycoplasmas – Joker's of plant Kingdom
- (136) (C). Coniferopsida
- (137) (D). Riccia. Because it is a bryophyte
- (138) (C). Vascular – mean having xylem and phloem tissues.
- (139) (D).
- (140) (D). Kangaroo  
 Kangarro = pouched mammal.  
 (B) and (C) are egg laying mammals
- (141) (A).
- (142) (C). Internal fertilization and external development  
 They are land eggs. E.g. reptiles
- (143) (C). All vertebrates are chordates but all chordates are not vertebrates.  
 Cephalochordate do not posses spinal cord.
- (144) (D). Epidermis, lens of eye, spinal cord is ectodermal in origin.
- (145) (C).
- (146) (D). (A), (B) and (C) have bilaterally symmetrical adults.
- (147) (C).
- (148) (D). Obelia is coelenterate. Hence it is tissue grade.
- (149) (C). Round worms are pseudocoelomates belong to the phylum Aschelmenthes.
- (150) (D).
- (151) (A). According to binomial system of nomenclature the name of plant and animal is composed of two latin or latinized word. e.g., Potato is *Solanum tuberosum*. The first word (Solanum) indicate the generic name and second word (tuberosum) denotes the specific name.
- (152) (B). Species occupies a key position in classification. It is a basic unit of classification/taxonomy.
- (153) (C). In the natural system of classification organisms are arranged according to their natural affinities through the use of all important permanent. Characteristics such as structural, cytological, reproductive and biochemical. The characters are useful in bringing out homology
- (154) (A). The 'Binomial system of nomenclature' was explained by Carl Linnaeus in his book 'species plantarum' in 1753. According to this system name of any organism/plant consist of two words. First represents its 'genera' and second its 'species'.
- (155) (C). In five kingdom classification of Whittaker eukaryotes were assigned to only four of the five kingdom. Prokaryotes are includes in kingdom - monera
- (156) (A). (157) (D). (158) (A).
- (159) (C). (160) (D). (161) (D).
- (162) (B).  
 (i) Named virus : D.J. Ivanowsky  
 (ii) *Contagium vivum fluidum* : M.W. Beijerinck  
 (iii) viruses could be crystallised : W.M. Stanley  
 (iv) Viroids : T.O. Diener
- (163) (D). Protista includes all single-celled eukaryotes such as Chrysoophytes, Dinoflagellates, Euglenoids, Slime-moulds and Protozoans.  
 Phycomycetes, Ascomycetes, Basidiomycetes and Deuteromycetes are the four classes under fungi kingdom.
- (164) (C). *Cephaleuros virescens* is a member of class Chlorophyceae and cause disease red rust of tea leaf (*Thea sinensis*).
- (165) (C). Many algae important constituent of human food in future because the algae can grow easily and obtained protein, lipid carbohydrates and vitamins. e.g., Chlorella, Ulva.
- (166) (A). *Chlorella vulgaris* : This is the source of protein. This is rounded unicellular algae related to class Chlorophyceae.
- (167) (C). The main plant of bryophyta is gametophyte. Gametophytic stage is independent.
- (168) (C).

- (169) (D). The gymnosperms are heterosporous; they produce haploid microspores and megaspores. The two kinds of spores are produced within sporangia that are borne on sporophylls which are arranged spirally along an axis to form lax or compact strobili or cones.
- (170) (C). Stomata are primitive because guard cells are not found. Only stomatal pores are found.
- (171) (C). Protonema : It is green, septate, filamentous algae like which is borne after the germination of moss haploid spores.
- (172) (C). Phaeophyceae: The plant body is usually attached to the substratum by a holdfast, and has a stalk, the stipe and leaf like photosynthetic organ – the frond.
- (173) (B). Autotrophic nutrition is a common feature to gametophytes and sporophytes of mosses and fern because chlorophyll containing cells found in both which are assimilatory in function.
- (174) (C). Notochord is the prime diagnostic feature of phylum chordata. Chordates possess notochord either throughout whole life or during early embryonic period.
- (175) (C). (A) Hagfish : Class – *Cyclostomata*  
 (B) Dog fish : Class – *Chondrichthyes*  
 (C) Flying fish : Class – *Osteichthyes*  
 (D) Salamander : Class – *Amphibia*
- (176) (B). The name '*platyhelminthes*' has been derived from two Greek words –*platys* meaning broad or flat; and *helmins* or *helminthos* means worms. The name '*platyhelminthes*' was first proposed by *Gegenbauer* in 1859.
- (177) (C). (178) (B).
- (179) (C). (a) *Pleurobrachia* : Ctenophora  
 (b) *Aurelia* : Coelenterata  
 (c) *Fasciola* : Platyhelminthes  
 (d) *Ascaris* : Aschelminthes
- (180) (C).